

Mechaninės pavaros ir automatizavimo elementai

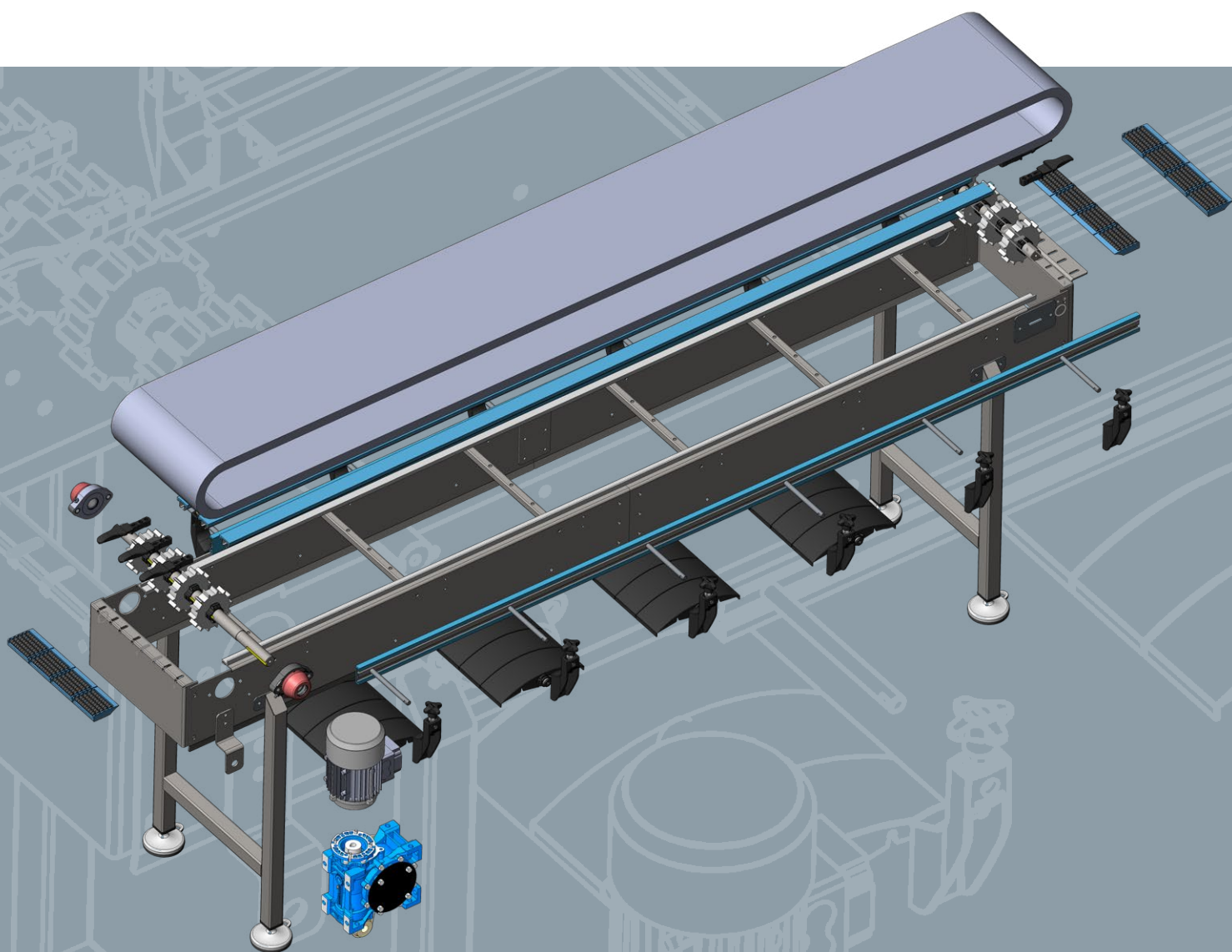

10. Signalinės lempos



11. Ritiniai ir gravitacinės sandėliavimo sistemos

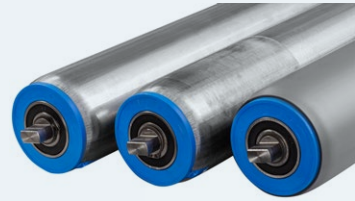

9. Įrenginių eksploatacinės medžiagos



7. Davikliai



6. Automatikos komponentai ir komutacinės spintos



8. Tepalų eksploatavimo sprendimai



12. Konvejerių juostos, komponentai ir posūkliai



1. Elektros varikliai

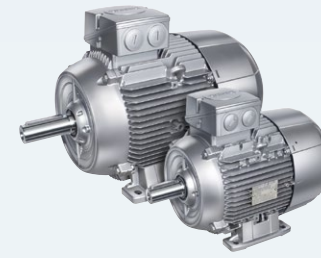

2. Reduktoriai

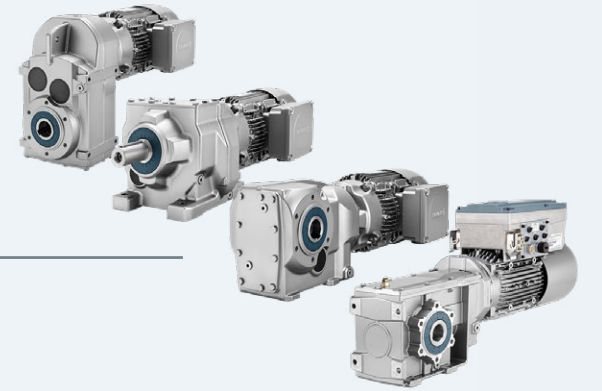

3. Movos

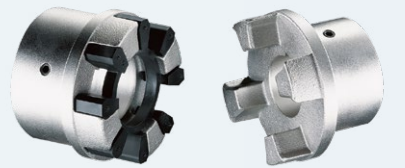

13. Paslaugos

5. Dažnio keitikliai



4. Galiniai išjungėjai ir saugos grandinių komponentai

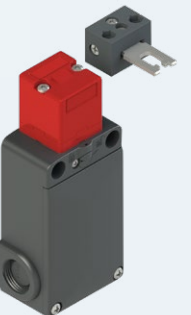

1. Elektros varikliai

1. Trifaziai, vienfaziai, su stabdžiu, ATEX

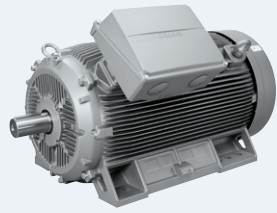

2. Būgniniai

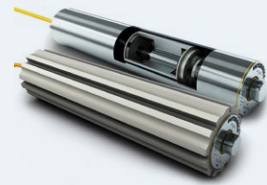

3. Žemo centro

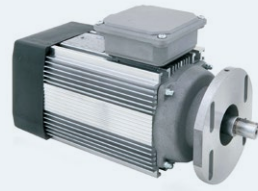

4. Nuolatinės srovės



5. Vibrovarikliai



6. Mikro serijos vibrovarikliai



2. Reduktoriai

1. Sliekiniai



2. Cilindriniai



3. Kūginiai

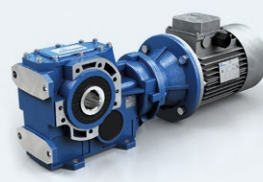

4. Lygiagrečių velenu



5. Variatoriai



6. Industriniai

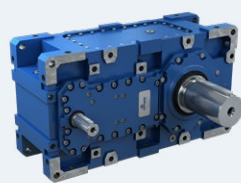

7. Planetiniai



8. Ant veleno montuojami



9. Kampiniai

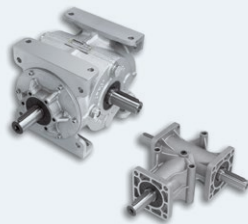

10. Sraigtinės pavaros

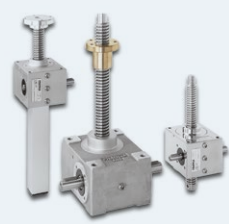

11. Mini serijos pavaros



12. Precizinės pavaros

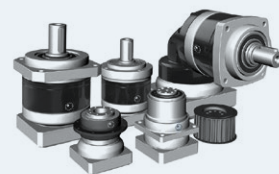

Šias prekes sandėliuojame, todėl galime išsiųsti per 1 darbo dieną.

Esame sertifikuotas Motovario surinkimo centras ir galime vietoje sukombinuoti platų asortimentą reduktorių pagal kliento poreikį.

3. Movos

1. VIVA



2. N-Eupex

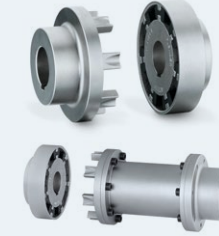

3. Hidro



4. Perkrovos



5. Lifelign

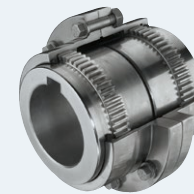

6. Steelflex

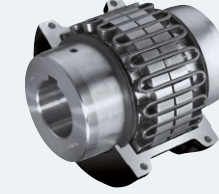

7. Rupex



8. Wrapflex



4. Galiniai išjungėjai ir saugos grandinių komponentai



5. Dažnio keitikliai

1. Sinus B



2. Sinus M



3. Sinus Penta



4. Sinamics V20



5. Sinamics G120



6. Sinamics S120



6. Automatikos komponentai ir komutacinės spintos

1. Mygtukai, rankenėlės



2. PLC valdikliai



3. Žemos įtampos komutacinė įranga



4. Komutacinės spintos



7. Davikliai

1. Davikliai ir enkoderiai



2. Kameros



3. Saugos užolaidos



4. Priedai



8. Tepalų eksploatavimo sprendimai

1. Drėgmę šalinantys alsuokliai



2. Indikatoriai



3. Mobilios filtravimo stotys



4. Dozavimas ir saugojimas



9. Įrenginių eksploatacinės medžiagos

1. Nichrominės vielos ir juostos

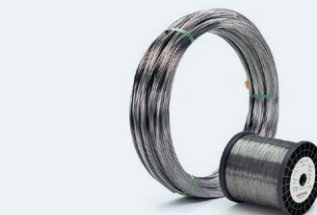

2. Silikoninės gumos lakštai ir profiliai



3. Tefloniniai audiniai ir diržai



10. Signalinės lempos

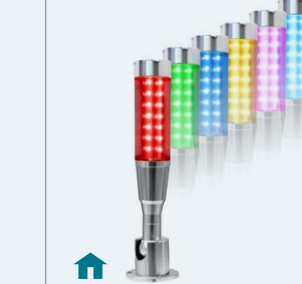
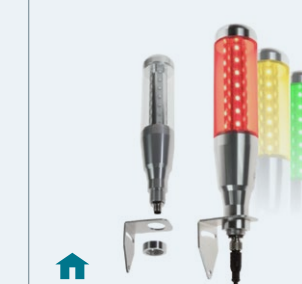
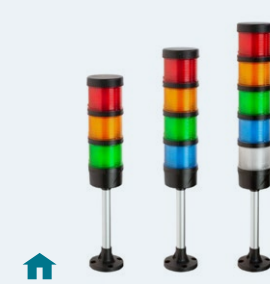

11. Ritinėliai ir gravitacinės sandėliavimo sistemos

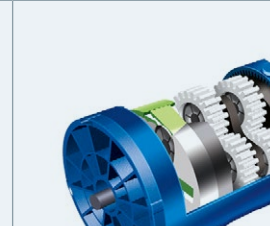

12. Konvejerių juostos, komponentai ir posūkiai

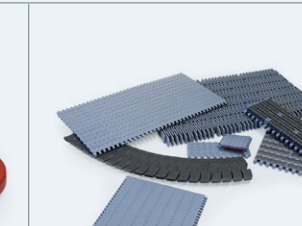

13. Paslaugos

Automatizavimo paslaugos

- Valdiklių programavimas (S7-1200, 1500, LOGO)
- Dažnio keitiklių parinkimas, derinimas ir paleidimas
- SCADA, HMI panelių vizualizacijos programavimas
- Kamelių ir sensorių konfigūravimas

Variklių ir reduktorių paslaugos

- Surinkimas
- Remontas
- Modifikavimas
- Techninis aptarnavimas



1994 m.

dirbame nuo

243

darbuotojai

>1000

klientų

Latvija
Vokietija

filialai

MŪSŪ PARTNERIAI:

SIEMENS



FLENDER
A Siemens Company

